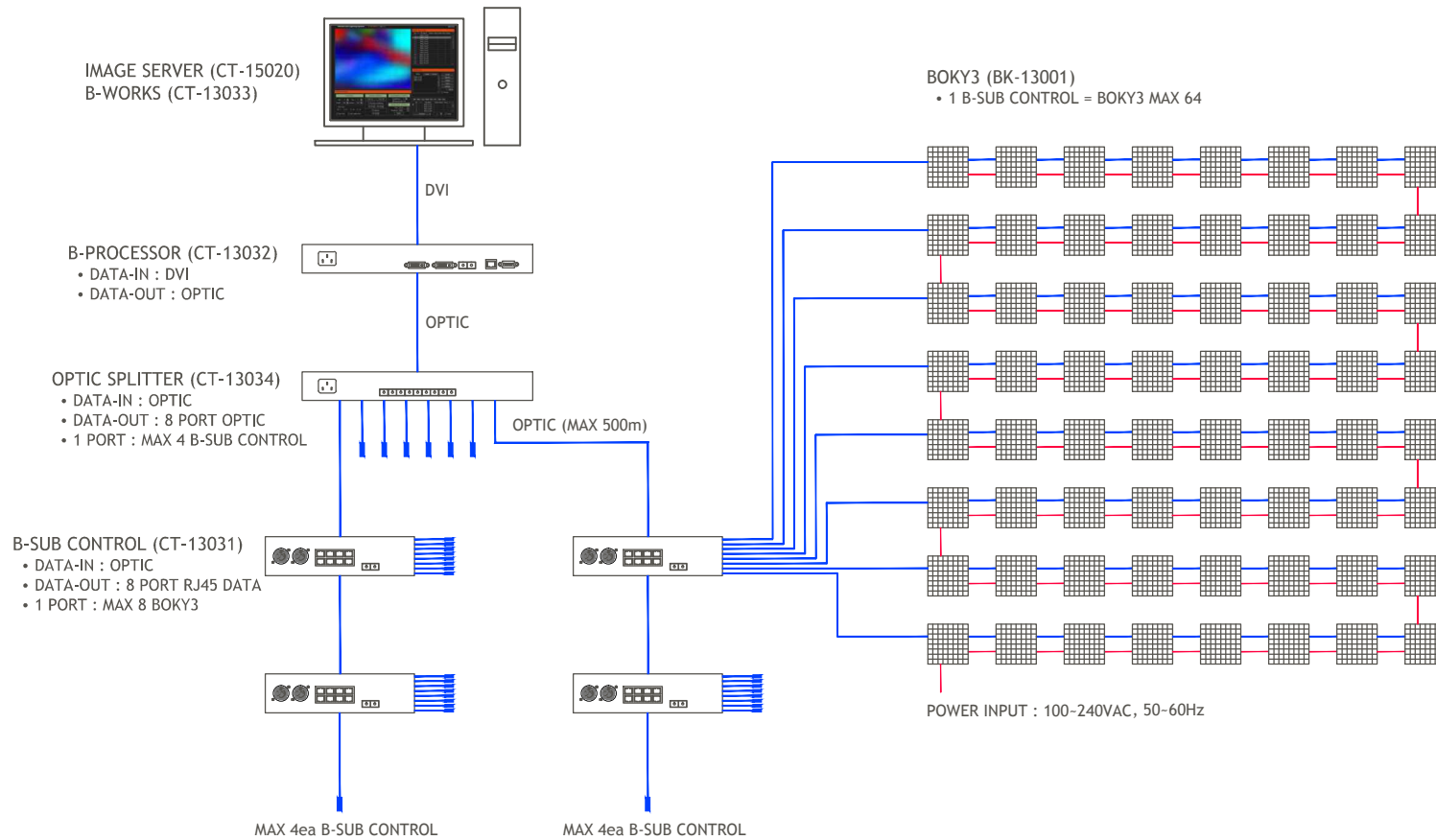

IMAGE-LED Lighting System

BOKY3 (BK-13001)



PROJECT NAME
TITLE NAME BOKY3 WIRING DIAGRAM
REVISIONS DATE 1. _____ DATE 2. _____ DATE 3. _____
APPROVED BY
CHECKED BY
DRAWING BY
MEMO
SCALE A3 : 1/10
DRAWING NO.
DATE 2010. 4
SHEET NO.

IMAGE-LED Lighting System

BOKY3 (BK-13001)

※ Example – BOKY3 144set<Width 12, Height 12>

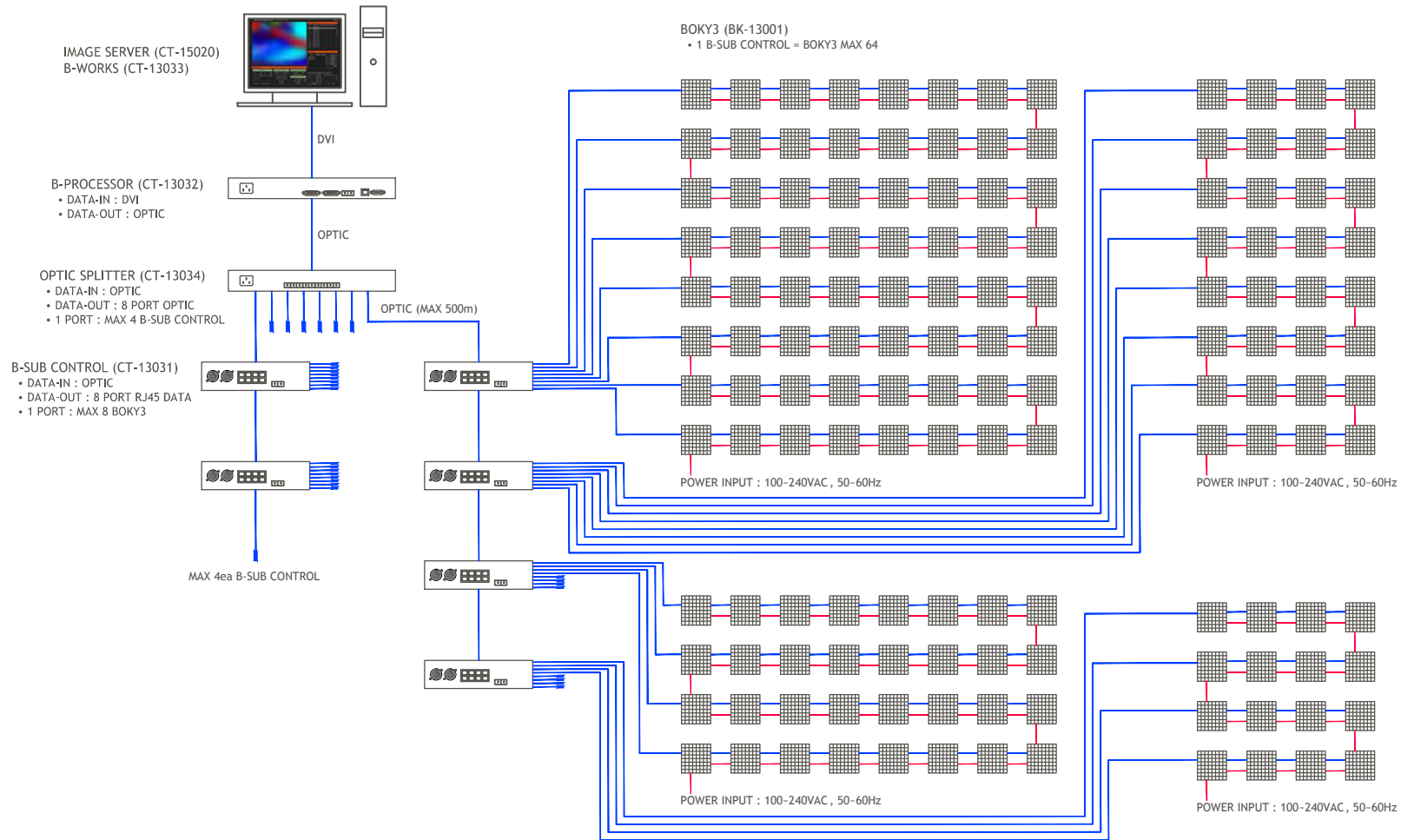

PROJECT NAME
TITLE NAME BOKY3 WIRING DIAGRAM
REVISIONS DATE 1. _____ DATE 2. _____ DATE 3. _____
APPROVED BY
CHECKED BY
DRAWING BY
MEMO
SCALE A3 : 1/10
DRAWING NO.
DATE 2010. 4
SHEET NO.